



- LTM**
Line thermal magnetic protection
- LTMD**
Selective thermal magnetic protection
- GTM**
Generator thermal magnetic protection
- Mag Break™**
Magnetic Only protection
- Y**
Non Automatic or switch (not mentioned in tables)

FD Frame

Breaking capacities

2, 3 and 4 pole types

Single pole types

Icu 400/415V AC
in kA eff.

Icu 230/240V AC
in kA eff.

Type	C	E	S	N	H	L	N	H
FD63	18	25	36	50	80	150		
FD160	18	25	36	50	80	150	25	50

Protection

Trip Unit	Rated Current (A)	FD63 (2,3 & 4 pole)				FD160 (single pole)		
		LTM	LTMD	GTM	Mag Break™	Trip Unit	Rated Current (A)	LTM
FD63 (2,3 & 4 pole)	3				N,H			
	7				N,H			
	12.5				N,H			
	16	C,E	S,N,H			16	N,H	
	20	C,E	S,N,H		N,H,L	20	N,H	
	25	C,E	S,N,H,L	N,H		25	N,H	
	30				N,H,L			
	32	C,E	S,N,H,L	N,H		32	N,H	
FD160 (2,3 & 4 pole)	40	C,E	S,N,H,L	N,H		40	N,H	
	50	C,E	S,N,H,L	N,H	N,H,L	50	N,H	
	63	C,E	S,N,H,L	N,H		63	N,H	
	80	C,E	S,N,H,L	N,H	N,H,L	80	N,H	
	100	C,E	S,N,H,L	N,H	N,H,L	100	N,H	
	125	C,E	S,N,H,L	N,H		125	N,H	
	160	C,E	S,N,H,L	N,H		160	N,H	

Number of poles/protected poles (trips)	FD63 (2,3 & 4 pole)				FD160 (single pole)		
2 pole 2 trips			N			1 pole 1 trip	N,H
3 pole 3 trips	C,E	S,N,H,L	N,H	N,H,L			
4 pole 3 trips		N,H,L	N,H	N,H,L			
4 pole 4 trips	C,E	S,N,H,L	N,H				
4 pole 3.5 trips (N=50%) ⁽²⁾		N,H,L	N,H				

Accessories

- ① Auxiliary contact left mounted (NO or NC)
- ② Auxiliary contact right mounted (NO or NC)
- ③ Bell Alarm trip unit (NO or NC)
- ④ Bell Alarm mechanism (CO)⁽¹⁾
- ⑤ Shunt or Undervoltage release
- ⑥ Operators
 - Rotary Handle
 - Electrical Operator
- ⑦ RCD, side or bottom mounted (Insert indicates Bell alarm contact mounting)
- ⑧ Plug in system⁽¹⁾

(1) Not applicable for the FDC types.
(2) Rated current ≥ 63A

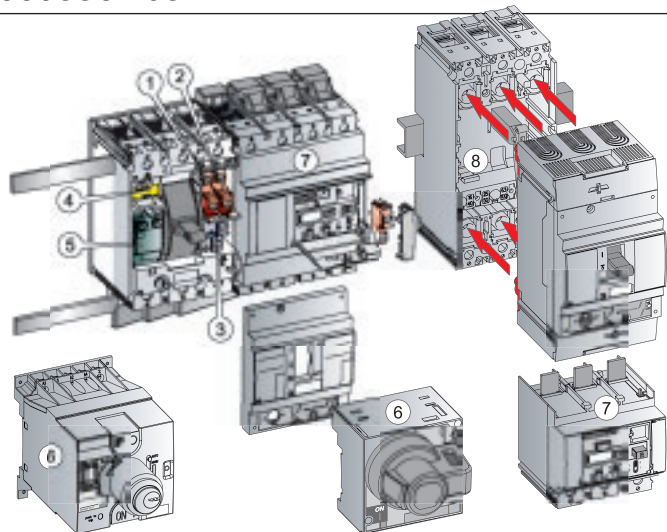

FD63/160 - Complete Circuit Breaker

Line Thermal Magnetic LTM (fixed settings)



In (A)	3 pole 3 trips		4 pole 4 trips ⁽¹⁾	
	Cat. nr.	Ref. nr.	Cat. nr.	Ref. nr.
16	FDC35TE016EF	433532	FDC45TC016EF	433926
20	FDC35TE020EF	433553	FDC45TC020EF	433928
25	FDC35TE025EF	433864	FDC45TC025EF	433930
32	FDC35TE032EF	433867	FDC45TC032EF	433932
40	FDC35TE040EF	436870	FDC45TC040EF	433934
50	FDC35TE050EF	436873	FDC45TC050EF	433936
63	FDC35TE063EF	436876	FDC45TC063EF	433938
80	FDC35TE080GF	436879	FDC45TC080GF	433940
100	FDC35TE100GF	436882	FDC45TC100GF	433942
125	FDC35TE125GF	433885	FDC45TC125GF	433944
160	FDC35TE160GF	433899	FDC45TC160GF	433946

One code covers a standard, fixed front connection breaker with:
 * Fixation hardware.

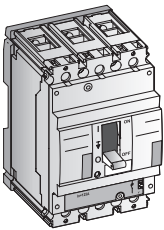

In (A)	3 pole 3 trips		4 pole 4 trips ⁽¹⁾	
	Cat. nr.	Ref. nr.	Cat. nr.	Ref. nr.
16	FDC35TE016ED	433907	FDC45TE016ED	433948
20	FDC35TE020ED	433911	FDC45TE020ED	433949
25	FDC35TE025ED	433914	FDC45TE025ED	433950
32	FDC35TE032ED	433918	FDC45TE032ED	433951
40	FDC35TE040ED	436117	FDC45TE040ED	433952
50	FDC35TE050ED	436118	FDC45TE050ED	433953
63	FDC35TE063ED	436133	FDC45TE063ED	433954
80	FDC35TE080GD	436143	FDC45TE080GD	436145
100	FDC35TE100GD	436144	FDC45TE100GD	436146
125	FDC35TE125GD	433924	FDC45TE125GD	436147
160	FDC35TE160GD	433925	FDC45TE160GD	436148

One code covers a standard, fixed front connection breaker with:
 * DIN-Rail mounting kit
 * Breaker finishing covers * Fixation hardware.

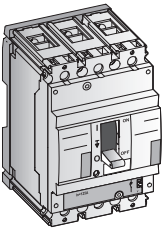

In (A)	3 pole 3 trips		4 pole 4 trips ⁽¹⁾	
	Cat. nr.	Ref. nr.	Cat. nr.	Ref. nr.
16	FDE36TF016EF	435127	FDE46TF016EF	435207
20	FDE36TF020EF	435129	FDE46TF020EF	435229
25	FDE36TF025EF	435130	FDE46TF025EF	435231
32	FDE36TF032EF	435132	FDE46TF032EF	435238
40	FDE36TF040EF	435135	FDE46TF040EF	435240
50	FDE36TF050EF	435138	FDE46TF050EF	435242
63	FDE36TF063EF	435145	FDE46TF063EF	435244
80	FDE36TF080GF	435147	FDE46TF080GF	435246
100	FDE36TF100GF	435193	FDE46TF100GF	435248
125	FDE35TF125GF	435195	FDE45TF125GF	435256
160	FDE35TF160GF	435205	FDE45TF160GF	435258

One code covers a standard, fixed front connection breaker with:
 * DIN-Rail mounting kit
 * Breaker finishing covers * Fixation hardware.

Line Thermal Magnetic LTM (adjustable thermals)



In (A)	3 pole 3 trips		4 pole 4 trips ⁽¹⁾	
	Cat. nr.	Ref. nr.	Cat. nr.	Ref. nr.
16	FDE35TC016EF	430001	FDE45TC016EF	430008
20	FDE35TC020EF	430002	FDE45TC020EF	430009
25	FDE35TC025EF	430003	FDE45TC025EF	430010
32	FDE35TC032EF	430004	FDE45TC032EF	430011
40	FDE35TC040EF	430005	FDE45TC040EF	430012
50	FDE35TC050EF	430006	FDE45TC050EF	430013
63	FDE35TC063EF	430007	FDE45TC063EF	430014
80	FDE35TC080GF	430276	FDE45TC080GF	430299
100	FDE35TC100GF	430279	FDE45TC100GF	430302
125	FDE35TC125GF	430282	FDE45TC125GF	430305
160	FDE35TC160GF	433566	FDE45TC160GF	433569

One code covers a standard, fixed front connection breaker with:
 * Fixation hardware.

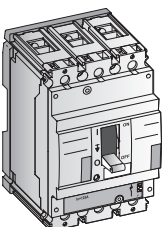

In (A)	3 pole 3 trips		4 pole 4 trips ⁽¹⁾	
	Cat. nr.	Ref. nr.	Cat. nr.	Ref. nr.
16	FDE35TE016ED	433649	FDE45TE016ED	433697
20	FDE35TE020ED	433651	FDE45TE020ED	433699
25	FDE35TE025ED	433653	FDE45TE025ED	433701
32	FDE35TE032ED	433655	FDE45TE032ED	433703
40	FDE35TE040ED	433657	FDE45TE040ED	433705
50	FDE35TE050ED	433659	FDE45TE050ED	433707
63	FDE35TE063ED	433661	FDE45TE063ED	433709
80	FDE35TE080GD	433663	FDE45TE080GD	433711
100	FDE35TE100GD	433665	FDE45TE100GD	433713
125	FDE35TE125GD	433667	FDE45TE125GD	433715
160	FDE35TE160GD	433669	FDE45TE160GD	433717

One code covers a standard, fixed front connection breaker with:
 * DIN-Rail mounting kit
 * Breaker finishing covers * Fixation hardware.

(1) Neutral on the left. If neutral on the right is needed, please contact us.



FD63/160 - Complete Circuit Breaker

Selective Thermal Magnetic LTMD (settable thermals)

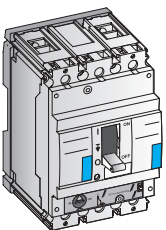
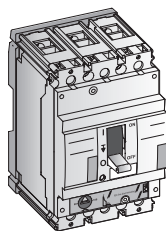

In (A)	3 pole 3 trips		4 pole 4 trips ⁽¹⁾		Cat. nr.	Ref. nr.	Cat. nr.	Ref. nr.
	Cat. nr.	Ref. nr.	Cat. nr.	Ref. nr.				
36 kA FDS	16	FDS35TD016ED	430161	FDS45TD016ED	430224			
	20	FDS35TD020ED	430163	FDS45TD020ED	430226			
	25	FDS35TD025ED	430165	FDS45TD025ED	430228			
	32	FDS35TD032ED	430167	FDS45TD032ED	430230			
	40	FDS35TD040ED	430169	FDS45TD040ED	430232			
	50	FDS35TD050ED	430178	FDS45TD050ED	430241			
	63	FDS35TD063ED	432952	FDS45TD063ED	432964			
	80	FDS35TD080GD	432955	FDS45TD080GD	432967			
	100	FDS35TD100GD	432958	FDS45TD100GD	432970			
	125	FDS35TD125GD	432961	FDS45TD125GD	432973			
160	FDS35TD160GD	433602	FDS45TD160GD	433604				
50kA FDN	2 pole 2 trips							
	16	FDN66TD016ED	430143					
	20	FDN66TD020ED	430144					
	25	FDN66TD025ED	430145					
	32	FDN66TD032ED	430146					
	40	FDN66TD040ED	430147					
	50	FDN66TD050ED	430148					
	63	FDN66TD063ED	430149					
	80	FDN66TD080GD	430794					
	100	FDN66TD100GD	430797					
125	FDN66TD125GD	430800						
160	FDN66TD160GD	433599						

One code covers: A standard fixed front connection breaker + DIN-Rail mounting kit + Toggle elongator + Breaker finishing covers + Fixation hardware

Line Thermal Magnetic LTM (fixed settings)

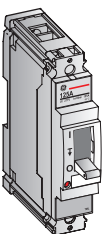

In (A)	1 pole 1 trip		240V 50kA FDH	1 pole 1 trip	
	Cat. nr.	Ref. nr.		Cat. nr.	Ref. nr.
240V 25kA FDN	16	FDN13TF016EF	433316	FDH13TF016EF	433246
	20	FDN13TF020EF	433322	FDH13TF020EF	433255
	25	FDN13TF025EF	433328	FDH13TF025EF	433262
	32	FDN13TF032EF	433334	FDH13TF032EF	433268
	40	FDN13TF040EF	433340	FDH13TF040EF	433274
	50	FDN13TF050EF	433346	FDH13TF050EF	433280
	63	FDN13TF063EF	433352	FDH13TF063EF	433286
	80	FDN13TF080GF	433519	FDH13TF080GF	433292
	100	FDN13TF100GF	433522	FDH13TF100GF	433298
	125	FDN13TF125GF	433525	FDH13TF125GF	433304
160	FDN13TF160GF	433527	FDH13TF160GF	433310	

Selective Thermal Magnetic LTMD (settable thermals)

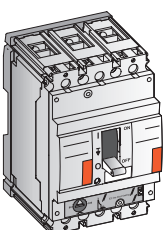
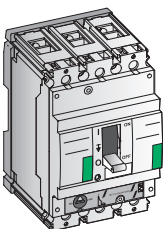
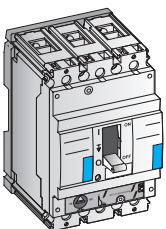

In (A)	3 pole 3 trips		4 pole 3 trips ⁽¹⁾		4 pole 4 trips ⁽¹⁾		4 pole 3.5 trips (N=50%) ⁽¹⁾		
	Cat. nr.	Ref. nr.	Cat. nr.	Ref. nr.	Cat. nr.	Ref. nr.	Cat. nr.	Ref. nr.	
50kA FDN	16	FDN36TD016ED	430100	FDN436TD016ED	430117	FDN46TD016ED	430131	-	-
	20	FDN36TD020ED	430101	FDN436TD020ED	430118	FDN46TD020ED	430132	-	-
	25	FDN36TD025ED	430102	FDN436TD025ED	430119	FDN46TD025ED	430133	-	-
	32	FDN36TD032ED	430103	FDN436TD032ED	430120	FDN46TD032ED	430134	-	-
	40	FDN36TD040ED	430104	FDN436TD040ED	430121	FDN46TD040ED	430135	-	-
	50	FDN36TD050ED	430105	FDN436TD050ED	430122	FDN46TD050ED	430136	-	-
	63	FDN36TD063ED	430106	FDN436TD063ED	430123	FDN46TD063ED	430137	FDN456TD063ED	430129
	80	FDN36TD080GD	430630	FDN436TD080GD	430688	FDN46TD080GD	430752	FDN456TD080GD	430718
	100	FDN36TD100GD	430633	FDN436TD100GD	430691	FDN46TD100GD	430755	FDN456TD100GD	430721
	125	FDN36TD125GD	430636	FDN436TD125GD	430694	FDN46TD125GD	430758	FDN456TD125GD	430724
160	FDN36TD160GD	433572	FDN436TD160GD	433578	FDN46TD160GD	433590	FDN456TD160GD	433584	
80kA FDH	16	FDH36TD016ED	430020	FDH436TD016ED	430037	FDH46TD016ED	430051	-	-
	20	FDH36TD020ED	430021	FDH436TD020ED	430038	FDH46TD020ED	430052	-	-
	25	FDH36TD025ED	430022	FDH436TD025ED	430039	FDH46TD025ED	430053	-	-
	32	FDH36TD032ED	430023	FDH436TD032ED	430040	FDH46TD032ED	430054	-	-
	40	FDH36TD040ED	430024	FDH436TD040ED	430041	FDH46TD040ED	430055	-	-
	50	FDH36TD050ED	430025	FDH436TD050ED	430042	FDH46TD050ED	430056	-	-
	63	FDH36TD063ED	430026	FDH436TD063ED	430043	FDH46TD063ED	430057	FDH456TD063ED	430049
	80	FDH36TD080GD	430338	FDH436TD080GD	430396	FDH46TD080GD	430460	FDH456TD080GD	430426
	100	FDH36TD100GD	430341	FDH436TD100GD	430399	FDH46TD100GD	430463	FDH456TD100GD	430429
	125	FDH36TD125GD	430344	FDH436TD125GD	430402	FDH46TD125GD	430466	FDH456TD125GD	430432
160	FDH36TD160GD	435821	FDH436TD160GD	435827	FDH46TD160GD	435839	FDH456TD160GD	435833	
150kA FDL	25	FDL36TD025ED	430070	FDL436TD025ED	430082	FDL46TD025ED	430090	-	-
	32	FDL36TD032ED	430071	FDL436TD032ED	430083	FDL46TD032ED	430091	-	-
	40	FDL36TD040ED	430072	FDL436TD040ED	430084	FDL46TD040ED	430092	-	-
	50	FDL36TD050ED	430073	FDL436TD050ED	430085	FDL46TD050ED	430093	-	-
	63	FDL36TD063ED	430074	FDL436TD063ED	430086	FDL46TD063ED	430094	FDL456TD063ED	430087
	80	FDL36TD080GD	430518	FDL436TD080GD	430557	FDL46TD080GD	430591	FDL456TD080GD	430568
	100	FDL36TD100GD	430521	FDL436TD100GD	430560	FDL46TD100GD	430594	FDL456TD100GD	430571
125	FDL36TD125GD	430524	FDL436TD125GD	430563	FDL46TD125GD	430597	FDL456TD125GD	430574	
160	FDL36TD160GD	435845	FDL436TD160GD	435848	FDL46TD160GD	435854	FDL456TD160GD	435851	

One code covers: A standard fixed front connection breaker + DIN-Rail mounting kit + Toggle elongator + Breaker finishing covers + Fixation hardware

(1) Neutral on the left. If neutral on the right is needed, please contact us.



FD63/160 - Complete Circuit Breaker

Generator Thermal Magnetic GTM (settable thermals)

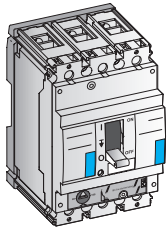

In (A)	3 pole 3 trips		4 pole 3 trips ⁽¹⁾		4 pole 4 trips ⁽¹⁾		4 pole 3.5 trips (N=50%) ⁽¹⁾	
	Cat. nr.	Ref. nr.	Cat. nr.	Ref. nr.	Cat. nr.	Ref. nr.	Cat. nr.	Ref. nr.
25	FDN36TG025ED	430107	FDN436TG025ED	430124	FDN46TG025ED	430138	-	-
32	FDN36TG032ED	430108	FDN436TG032ED	430125	FDN46TG032ED	430139	-	-
40	FDN36TG040ED	430109	FDN436TG040ED	430126	FDN46TG040ED	430140	-	-
50	FDN36TG050ED	430110	FDN436TG050ED	430127	FDN46TG050ED	430141	-	-
63	FDN36TG063ED	430111	FDN436TG063ED	430128	FDN46TG063ED	430142	FDN456TG063ED	430130
80	FDN36TG080GD	430649	FDN436TG080GD	430707	FDN46TG080GD	430771	FDN456TG080GD	430729
100	FDN36TG100GD	430652	FDN436TG100GD	430710	FDN46TG100GD	430774	FDN456TG100GD	430732
125	FDN36TG125GD	430655	FDN436TG125GD	430713	FDN46TG125GD	430777	FDN456TG125GD	430735
160	FDN36TG160GD	433575	FDN436TG160GD	433581	FDN46TG160GD	433593	FDN456TG160GD	433587

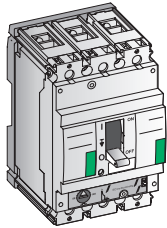

25	FDH36TG025ED	430027	FDH436TG025ED	430044	FDH46TG025ED	430058	-	-
32	FDH36TG032ED	430028	FDH436TG032ED	430045	FDH46TG032ED	430059	-	-
40	FDH36TG040ED	430029	FDH436TG040ED	430046	FDH46TG040ED	430060	-	-
50	FDH36TG050ED	430030	FDH436TG050ED	430047	FDH46TG050ED	430061	-	-
63	FDH36TG063ED	430031	FDH436TG063ED	430048	FDH46TG063ED	430062	FDH456TG063ED	430050
80	FDH36TG080GD	430357	FDH436TG080GD	430415	FDH46TG080GD	430479	FDH456TG080GD	430437
100	FDH36TG100GD	430360	FDH436TG100GD	430418	FDH46TG100GD	430482	FDH456TG100GD	430440
125	FDH36TG125GD	430363	FDH436TG125GD	430421	FDH46TG125GD	430485	FDH456TG125GD	430443
160	FDH36TG160GD	435824	FDH436TG160GD	435830	FDH46TG160GD	435842	FDH456TG160GD	435836

One code covers: A standard fixed front connection breaker + DIN-Rail mounting kit + Toggle elongator + Breaker finishing covers + Fixation hardware

Motor Protection (Mag Break™) Magnetic Only Breakers

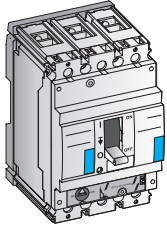

In (A)	3 pole		4 pole ⁽¹⁾	
	Cat. nr.	Ref. nr.	Cat. nr.	Ref. nr.
3	FDN36MC003ED	436409	FDN436MC003ED	436411
7	FDN36MC007ED	430095	FDN436MC007ED	430112
12.5	FDN36MC012ED	430096	FDN436MC012ED	430113
20	FDN36MC020ED	430097	FDN436MC020ED	430114
30	FDN36MC030ED	430098	FDN436MC030ED	430115
50	FDN36MC050ED	430099	FDN436MC050ED	430116
80	FDN36MC080GD	430610	FDN436MC080GD	430668
100	FDN36MC100GD	430613	FDN436MC100GD	430671

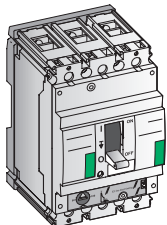

3	FDH36MC003ED	436396	FDH436MC003ED	436398
7	FDH36MC007ED	430015	FDH436MC007ED	430032
12.5	FDH36MC012ED	430016	FDH436MC012ED	430033
20	FDH36MC020ED	430017	FDH436MC020ED	430034
30	FDH36MC030ED	430018	FDH436MC030ED	430035
50	FDH36MC050ED	430019	FDH436MC050ED	430036
80	FDH36MC080GD	430318	FDH436MC080GD	430376
100	FDH36MC100GD	430321	FDH436MC100GD	430379

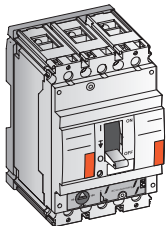

20	FDL36MC020ED	430065	FDL436MC020ED	430077
30	FDL36MC030ED	430066	FDL436MC030ED	430078
50	FDL36MC050ED	430067	FDL436MC050ED	430079
80	FDL36MC080GD	430498	FDL436MC080GD	430537
100	FDL36MC100GD	430501	FDL436MC100GD	430540

One code covers: A standard fixed front connection breaker + DIN-Rail mounting kit + Toggle elongator + Breaker finishing covers + Fixation hardware + IPXXB covers (Finger protection on connection clamps)

Complete Non-Automatic Circuit Breaker (Switch)

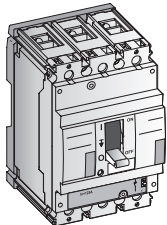

In (A)	3 pole		4 pole ⁽¹⁾	
	Cat. nr.	Ref. nr.	Cat. nr.	Ref. nr.
63	FDY306D063ED	430150	FDY406D063ED	430151
160	FDY306D160GD	430805	FDY406D160GD	430810

One code covers: A standard fixed front connection breaker + DIN-Rail mounting kit + Toggle elongator + Breaker finishing covers + Fixation hardware

(1) Neutral on the left. If neutral on the right is needed, please contact us.